

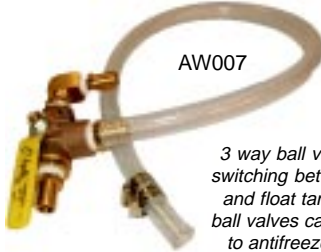

WATER & FUEL TANKS

TANK FEED ASSEMBLIES

- AW005 Tank Feed Kit
- AW006 3 Way Valve Kit, 4-6 gpm
- AW007 3 Way Ball Valve Kit 6-7 gpm
- AW010 3 Way Ball Valve 1" 10 gpm
- DFT12 Tank Adapter 3/4 PVC
- VF125 Filters 3/4 Y Type 200 Micron
- WT303 Filter 1" Sub For T3500 Hoss Mount



AW007

3 way ball valve kits allow switching between bulk tank and float tank. The 3 way ball valves can also be used to antifreeze the system.



AW005

WATER TANK PARTS

- HCS01 Tank Stainless Stl. Strap 190 Gal (2 RQD)
- WS300 Tank Cage 300 Gallon
- WT304 8" Lid 190 Gal & 300 Gal Tank (After 4/95)
- WT305 Tank Lid Assembly 15" (WT300)
- WT551 Tank Lid 550 Gallon

FLOAT TANK PARTS

- HL017 Float Tank Cap
- DFF10 Tank Bushing 5/8
- DQF10 Disconnect Barb/Tank Fitting (No Screen)
- DQF30 Anti-Freeze Air Chuck w/ Instruction Sheet
- VF050 Strainer Tube For 5/8 Barb (Float Tank)
- VVF08 Float Valve 3/8 Brass



WT304

Hydro Tek not only offers some of the highest capacity fuel tanks available, we isolate the tanks away from hot engines and mufflers to help prevent accidents when refueling.

WATER TANKS & ASSEMBLIES

- AW175 190 Gal. Tank Asm. w/ Filter
- AW300 Tank Asm. 300G w/ Cage
- WT175 Water Tank Poly 190G
- WT300 Water Tank 300G SQ (Cage RQD)
- WT302 Tank 300G w/ Fittings (Not Installed)
- WT550 Water Tank 550 Gallon

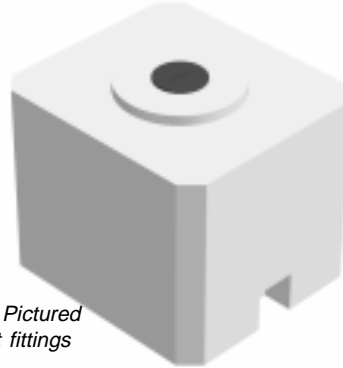

WT300 Pictured without fittings

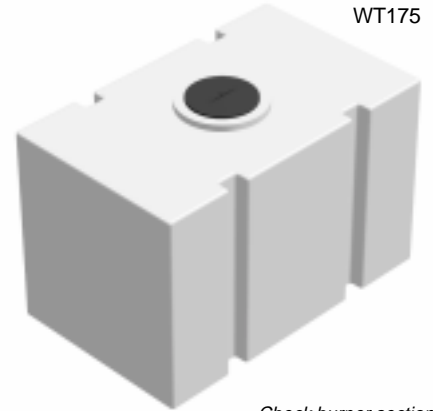

WT175

Check burner section for more fuel filters.

FLOAT TANKS

- WT040 Tank, Float 4 Gal HD Liner
- WT046 Float Tank Asm. w/ Valve (Specify Series)
- WT048 HP Float Tank Assembly
- WT051 Float Tank Assembly For HN30008

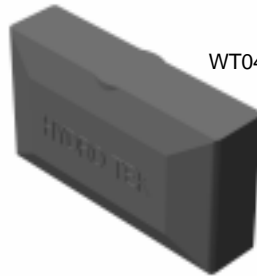

WT040

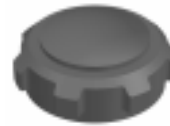

FUEL TANK PARTS

- BF025 Diesel Filter Cartridge
- DFF04 Fuel Tank Ell 1/4
- DFF04 Fuel Tank Bushing
- WT060 Tank Tie Strap 48"
- WT080 Fuel Cap, Diesel
- WT081 Fuel Cap, Gasoline

FUEL TANKS

- WT030 Gas Tank 2G Poly Red
- WT035 Diesel Tank 2G Poly Black
- WT075 Diesel Tank 7.5 Gal Clear
- WT078 Diesel Tank 18 Gal Clear
- WT07R Gas Tank 7.5 Gal Red



WT035



WT030

WT075



Fuel tanks are made of cross linked seamless polyethylene for fuel compatibility.



WT078

Tanks do not come with fittings and caps. Please order separately, installation is extra charge.

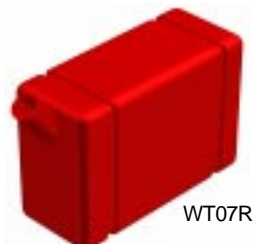

WT07R

Hydro Man Tip:



Improper connection of a pressure washer to a tank can be hazardous to the health of your pump. Use factory recommended filtration and size lines to factory specifications. Your valves and seals will thank you.